



MADE IN GREECE

KLAMKI I AKCESORIA **2023**

[www.zamontujto.pl](http://www.zamontujto.pl)



## HISTORIA

CONVEX powstał w 1991 roku. Jego założycielem jest Panagiotis PANTAZELOS, który działa w branży okuć od 1973 roku. Firma mieści się we własnych obiektach przy 93 G. Gennimata Avenue, Magoula, Attiki. Są to starannie zaprojektowane budynki spełniające najwyższe standardy. Convex jest jednostką zintegrowaną pionowo, a wszystkie etapy produkcji prowadzone są w zakładach własnych.

Produkty firmy to:

- klamki i gałki do drzwi,
- uchwyty i gałki meblowe,
- produkty wykonane na zamówienie.

Convex posiada rozległą sieć dealerów w całej Grecji, starannie wspierając i dostarczając im wiedzę techniczną zbudowaną dzięki wieloletniemu zaufaniu i doświadczeniu. Działalność eksportowa CONVEX obejmuje ponad 24 kraje na całym świecie dzięki inwestycjom w dziedzinie projektowania, a także dbałości o wszystkie szczegóły otaczające liczne aspekty wszystkich faz produkcji.

Convex, po analizie funkcji społecznych i ciągłym poszukiwaniu nowych, korzystniejszych materiałów poprawiających jakość życia, chroniących ludzi i środowisko, jako pierwsza firma w Grecji i jedna z pierwszych na świecie uzyskała certyfikat Copper Development Institute na produkcję produktów przeciwdrobnoustrojowych na bazie miedzi.

Od początku swojego funkcjonowania CONVEX jest firmą rodzinną. Aktualnie w jej prowadzenie włączone zostało drugie pokolenie, które ma ten sam zapał do kreowania innowacyjnego, stylowego, funkcjonalnego i wysokiej jakości produktu.

## KIM JESTEŚMY

Convex to grecki producent designerskich klamek wykonanych z najwyższej jakości materiałów. Łączy w sobie długie doświadczenie w produkcji wyrobów metalowych oraz dużą wiedzę techniczną projektantów.

Dzięki wysiłkowi znanych architektów i projektantów, kolekcja Convex odznacza się wyraźną elegancją, wyrafinowaniem, perfekcją wykończenia i unikalnością. Filozofię Convex najlepiej można opisać jako model czterofilarowy. Kreatywność, Innowacja, Technologia i Pasja.

## PROCES PRODUKCYJNY

CONVEX to pionowo zintegrowana firma produkcyjna, wykorzystująca w procesie produkcji różne metale i stopy, takie jak mosiądz, aluminium, odlewy ciśnieniowe na bazie cynku, stal nierdzewna, miedź itp. Całość sekwencji produkcyjnej odbywa się w naszych zakładach. W ten sposób cały proces jest w pełni kontrolowany. Pozwala to na dużą elastyczność we współpracy z klientami i kontrahentami na rynku greckim i międzynarodowym.

Działy produkcyjne CONVEX obejmują:



### PROJEKT PRODUKTU

W pełni wyposażona hala maszynowa, w której po projekcie produktu powstaje forma jako narzędzie produkcyjne wykorzystywane w procesie odlewania.



### ODLEWANIE CIŚNIENIOWE

złota i brązu w trzech prasach odlewniczych.



### AUTOMATYCZNE TOKARKI

do produkcji elementów obrabianych z mosiądzu i aluminium. Maksymalna średnica, która może zostać wyprodukowana to Ø 60 mm.



### DZIAŁ OBRÓBKI

przy użyciu maszyn transferowych specjalnie zbudowanych na potrzeby produkcyjne. Prasy do cięcia, wiertarki i piły służą również do wykańczania części wymiarowej i funkcjonalnej naszych produktów.



### WYKOŃCZENIE WIBRACYJNE

wykonywane jest jako wstępny etap obróbki metalu. Posiadamy również wiele ręcznych lub automatycznych maszyn do obróbki ściernej.



### DZIAŁ WYKOŃCZEŃ

gdzie końcowe polerowanie jest wykonywane w satynowym lub błyszczącym wykończeniu. W zależności od rozmiaru i geometrii części, stosowane są maszyny transferowe i zrobotyzowane.



### DZIAŁ GALWANIZACJI

gdzie w pełni automatyczna instalacja sterowana 7 nośnikami i posiadająca 70 zbiorników przetwarza całość produkowanych przez nas półfabrykatów. Metale do obróbki to mosiądz, złota, miedź, aluminium i stal nierdzewna. Procesy obejmują miedziowanie, niklowanie, mosiądzowanie i chromowanie, a także lakierowanie. Możliwa jest obróbka detali do 2,8 m długości i 1,3 m wysokości.



### PROSZKOWE LAKIEROWANIE ELEKTROSTATYCZNE I OKSYDOWANIE METALU

odbywa się na wydzielonym dziale dla części produktów, kończąc tym samym całość procesów obróbki niektórych produktów.



### KONTROLA JAKOŚCI

to osobny i najważniejszy dział, w którym przeprowadzane są kontrole w celu sprawdzenia, czy produkty spełniają określone normy w Systemie Kontroli Jakości CONVEX.



### MOCOWANIE, MONTAŻ I PAKOWANIE

gotowych produktów do przechowywania przed sprzedażą za pośrednictwem sieci dystrybucji.

## KONTROLA JAKOŚCI – GWARANCJE

CONVEX wdrożył zintegrowaną politykę jakości. Poprzez ustanowienie zasad kontroli dla wszystkich etapów – od surowca poprzez proces produkcji do produktu końcowego – CONVEX gwarantuje najwyższą jakość i satysfakcję klienta.



W listopadzie 2010 firma Convex uzyskała certyfikat do stosowania jej własnego systemu kontroli jakości według normy ISO 9001: 2008 a w marcu 2019 roku Convex uzyskał certyfikat zgodnie z normą dotyczącą zarządzania ochroną środowiska ISO 14001: 2015.



Starając się zapewnić najwyższą jakość swoich produktów, firma Convex współpracuje z akredytowanymi laboratoriami, w których przeprowadzane są testy wytrzymałościowe przeprowadzane podczas utleniania w kabinie solnej zgodnie z EN 1670: 2007 „Okucia budowlane – Odporność na korozję – Wymagania i metody badań.”



Convex oferuje gwarancję użytkowania na wszystkie klamki dla 500 000 cykli.



Convex oferuje 10 lat dodatkowych gwarancji odporności powierzchni na korozję dla wszystkich chromowanych klamek.



Convex współpracuje z uznanym włoskim laboratorium LAPI, gdzie bada odporność ogniową na klamki w kontrolowanym środowisku zgodnie z normą EN 1634-2:2008 („Badania kontrolne odporności na ogień i dym zamknięć do drzwi i otwieralnych okien oraz elementów okuć budowlanych”).



Convex przestrzega normy EN 1906:2012 „Okucia budowlane. Klamki i gałki drzwiowe z tarczami. Wymagania i metody badań” w celu oceny jakości swoich produktów. Wyniki, testy i ocena odpowiadają 8-cyfrowemu sortowaniu kodów wymagane przez tą normę.



**S02 - Mosiądz Satyna**



**S04 - Chrom**



**S05 - Nikiel Satyna**



**S06 - Biały Matowy**



**S19 - Czarny Matowy**



**S20 - Złoty**



**S23 - Bordowy**



**S24 - Chrom Satyna**



**S26 - Mosiądz Matowy**



**S73 - Mosiądz Antyczny**









































**S75 - Tytan**



**S77 - Brąz Matowy**



**S96 - Biały**

Klamki na rozetach SLIM			Klamki na rozetach kwadratowych			Klamki na rozetach okrągłych			designers & premium						
		model	strona					model	strona			model	strona		
		1605 SLIM	6		<b>New</b>	2425	16		<b>New</b>	2095	28		2405	38	
		1515 SLIM	7			1605	17			1755	29		2415	39	
		1505 SLIM	8			1555	18			425	29		2195	39	
		1495 SLIM	9			1535	18			1515	30-31		2165	40	
		1485 SLIM	10			1495	19			1505	32-33		<b>New</b>	1935	41
		1145 SLIM	11			1145	20			1485	34-35		<b>New</b>	1925	42
		865 SLIM	11			1125	21							1775	43
	<b>New</b>	2295 SLIM	13			1115	22							1745	44
	<b>New</b>	2285 SLIM	13			1085	23							1625	45
	<b>New</b>	2275 SLIM	14			865	24								
	<b>New</b>	2265 SLIM	14			925	25								
						785	26								
						697	26								



— SLIM —

NOWA  
ODSŁONA

KLAMKI NA ROZETACH SLIM

[www.zamontujto.pl](http://www.zamontujto.pl)

MODEL  
**1605 SLIM**

— SLIM —

NOWA  
ODSŁONA



Chrom Satyna - S24  
25-398



**BDR 185,00** 227,55



25-438 **WK 68,00** 83,64



25-432 **WB 68,00** 83,64



25-426 **WC 109,00** 134,07

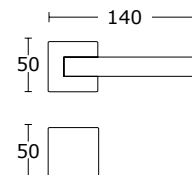

Czarny Matowy - S19  
25-397



**BDR 185,00** 227,55



25-436 **WK 68,00** 83,64



25-430 **WB 68,00** 83,64



25-424 **WC 109,00** 134,07

— SLIM —

NOWA  
ODSŁONA

MODEL  
**1515 SLIM**



Czarny Matowy - S19  
25-399



**BDR 185,00** 227,55



25-436 **WK 68,00** 83,64



25-430 **WB 68,00** 83,64



25-424 **WC 109,00** 134,07

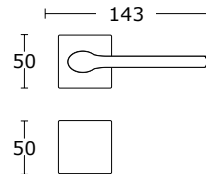

Nikiel Satyna - S05  
25-402



**BDR 185,00** 227,55



25-439 **WK 68,00** 83,64



25-433 **WB 68,00** 83,64



25-427 **WC 109,00** 134,07



Chrom Satyna - S24  
25-400



**BDR 185,00** 227,55



25-438 **WK 68,00** 83,64



25-432 **WB 68,00** 83,64



25-426 **WC 109,00** 134,07

MODEL  
**1505 SLIM**

— SLIM —

NOWA  
ODSŁONA



Chrom Satyna - S24  
25-406



**BDR 178,00** 218,94



25-438 **WK 68,00** 83,64



25-432 **WB 68,00** 83,64



25-426 **WC 109,00** 134,07

Mosiądz Satyna - S02  
25-405



**BDR 194,00** 238,62



25-437 **WK 74,00** 91,02



25-431 **WB 74,00** 91,02



25-425 **WC 119,00** 146,37

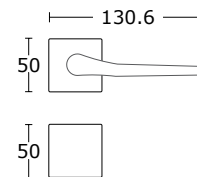

Czarny Matowy - S19  
25-404



**BDR 178,00** 218,94



25-436 **WK 68,00** 83,64



25-430 **WB 68,00** 83,64



25-424 **WC 109,00** 134,07



Nikiel Satyna - S05  
25-408



**BDR 178,00** 218,94



25-439 **WK 68,00** 83,64



25-433 **WB 68,00** 83,64



25-427 **WC 109,00** 134,07



— SLIM —

NOWA  
ODSŁONA

MODEL  
**1495 SLIM**



Czarny Matowy - S19  
25-410



BDR **185,00** 227,55



25-436 **WK 68,00** 83,64



25-430 **WB 68,00** 83,64



25-424 **WC 109,00** 134,07



Chrom - S04  
25-413



Nikiel Satyna - S05  
25-414



BDR **185,00** 227,55



25-439 **WK 68,00** 83,64



25-433 **WB 68,00** 83,64



25-427 **WC 109,00** 134,07



BDR **203,00** 249,69



25-435 **WK 74,00** 91,02



25-429 **WB 74,00** 91,02



25-383 **WC 119,00** 146,37

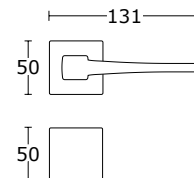

MADE  
IN  
GREECE



Mosiądz Satyna - S02  
25-411



Złoty - S20  
25-415



Chrom Satyna - S24  
25-412



BDR **203,00** 249,69



25-437 **WK 74,00** 91,02



25-431 **WB 74,00** 91,02



25-425 **WC 119,00** 146,37



BDR **203,00** 249,69



25-440 **WK 74,00** 91,02



25-434 **WB 74,00** 91,02



25-428 **WC 119,00** 146,37



BDR **185,00** 227,55



25-438 **WK 68,00** 83,64



25-432 **WB 68,00** 83,64



25-426 **WC 109,00** 134,07

CENA NETTO PLN / CENA BRUTTO PLN

[www.zamontujto.pl](http://www.zamontujto.pl)

MODEL  
**1485 SLIM**

— SLIM —

NOWA  
ODSŁONA



Mosiądz Satyna - S02  
25-419



**BDR 203,00** 249,69



25-437 **WK 74,00** 91,02



25-431 **WB 74,00** 91,02



25-425 **WC 119,00** 146,37



Czarny Matowy - S19  
25-564



**BDR 185,00** 227,55



25-436 **WK 68,00** 83,64



25-430 **WB 68,00** 83,64



25-424 **WC 109,00** 134,07



Chrom Satyna - S24  
25-416



**BDR 185,00** 227,55



25-438 **WK 68,00** 83,64



25-432 **WB 68,00** 83,64



25-426 **WC 109,00** 134,07

— SLIM —

NOWA  
ODSŁONA

MODEL  
**1145 SLIM**



Czarny Matowy - S19  
25-421



**BDR 226,00** 277,98



25-436 **WK 68,00** 83,64



25-430 **WB 68,00** 83,64



25-424 **WC 109,00** 134,07

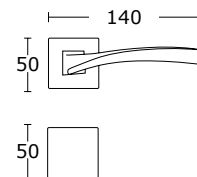

— SLIM —

NOWA  
ODSŁONA

MODEL  
**865 SLIM**



Chrom Satyna - S24  
25-423



**BDR 199,00** 244,77



25-438 **WK 68,00** 83,64



25-432 **WB 68,00** 83,64



25-426 **WC 109,00** 134,07



Czarny Matowy - S19  
25-362



**BDR 199,00** 244,77



25-436 **WK 68,00** 83,64



25-430 **WB 68,00** 83,64



25-424 **WC 109,00** 134,07

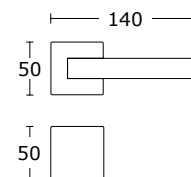

— SLIM —

NOWA  
LINIA

MODEL  
**2295 SLIM**

NOWA LINIA



Czarny Matowy - S19  
25-566



**BDR 125,00** 153,75



25-436 **WK 68,00** 83,64



25-430 **WB 68,00** 83,64



25-424 **WC 109,00** 134,07

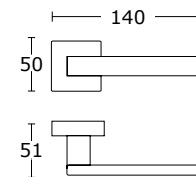

MODEL  
**2285 SLIM**

NOWA LINIA



Czarny Matowy - S19  
25-567



**BDR 125,00** 153,75



25-436 **WK 68,00** 83,64



25-430 **WB 68,00** 83,64



25-424 **WC 109,00** 134,07

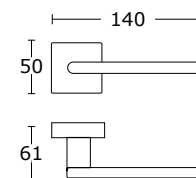



MODEL  
**2275 SLIM**

NOWA LINIA



Czarny Matowy - S19  
25-568



	<b>BDR</b> <b>125,00</b> 153,75
 25-436	<b>WK</b> <b>68,00</b> 83,64
 25-430	<b>WB</b> <b>68,00</b> 83,64
 25-424	<b>WC</b> <b>109,00</b> 134,07

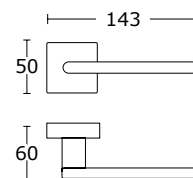





MODEL  
**2265 SLIM**

NOWA LINIA

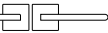

Czarny Matowy - S19  
25-569



	<b>BDR</b> <b>125,00</b> 153,75
 25-436	<b>WK</b> <b>68,00</b> 83,64
 25-430	<b>WB</b> <b>68,00</b> 83,64
 25-424	<b>WC</b> <b>109,00</b> 134,07

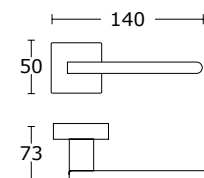



KLAMKI NA ROZETACH KWADRATOWYCH

[www.zamontujto.pl](http://www.zamontujto.pl)

MODEL  
**2425**

*Nowości*



Czarny Matowy - S19  
25-533



**BDR 188,00** 231,24



15-162 **WK 59,00** 72,57



15-163 **WB 59,00** 72,57



15-038 **WC 102,00** 125,46

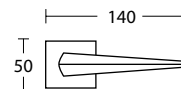

MADE  
IN  
GREECE



Chrom Satyna - S24  
25-532



**BDR 188,00** 231,24



15-160 **WK 59,00** 72,57



15-161 **WB 59,00** 72,57



15-029 **WC 102,00** 125,46



Chrom - S04  
25-534



**BDR 206,00** 253,38



15-180 **WK 64,90** 79,83



15-182 **WB 64,90** 79,83



15-032 **WC 112,00** 137,76



MODEL  
**1605**



Chrom Satyna - S24  
15-397



**BDR 178,00** 218,94



15-160 **WK 59,00** 72,57



15-161 **WB 59,00** 72,57



15-029 **WC 102,00** 125,46

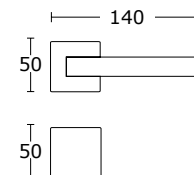

MADE  
IN  
GREECE



Nikiel Satyna - S05  
15-396



**BDR 178,00** 218,94



15-164 **WK 59,00** 72,57



15-165 **WB 59,00** 72,57



15-026 **WC 102,00** 125,46



Czarny Matowy - S19  
25-125



**BDR 178,00** 218,94



15-162 **WK 59,00** 72,57



15-163 **WB 59,00** 72,57



15-038 **WC 102,00** 125,46

MODEL  
**1555**



Czarny Matowy - S19  
15-400



**BDR 340,00** 418,20



15-162 **WK 59,00** 72,57



15-163 **WB 59,00** 72,57



15-038 **WC 102,00** 125,46

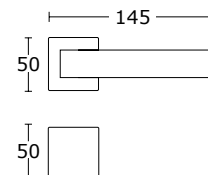

MODEL  
**1535**



Czarny Matowy - S19  
15-374



**BDR 201,00** 247,23



15-162 **WK 59,00** 72,57



15-163 **WB 59,00** 72,57



15-038 **WC 102,00** 125,46

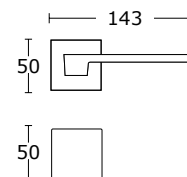



Chrom Satyna - S24  
15-340



**BDR 178,00** 218,94



15-160 **WK 59,00** 72,57



15-161 **WB 59,00** 72,57



15-029 **WC 102,00** 125,46



Chrom - S04  
15-341



Mosiądz Satyna - S02  
25-366



**BDR 195,00** 239,85



15-180 **WK 64,90** 79,83



15-182 **WB 64,90** 79,83



15-032 **WC 112,00** 137,76



**BDR 195,00** 239,85



25-370 **WK 64,90** 79,83



25-372 **WB 64,90** 79,83



25-371 **WC 112,00** 137,76

131

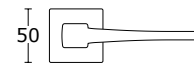

MADE  
IN  
GREECE



Nikiel Satyna - S05  
15-342



Czarny Matowy - S19  
25-189



Biały Matowy - S06  
25-505



**BDR 178,00** 218,94



15-164 **WK 59,00** 72,57



15-165 **WB 59,00** 72,57



15-026 **WC 102,00** 125,46



**BDR 178,00** 218,94



15-162 **WK 59,00** 72,57



15-163 **WB 59,00** 72,57



15-038 **WC 102,00** 125,46



**BDR 195,00** 239,85



25-517 **WK 64,90** 79,83



25-518 **WB 64,90** 79,83



25-519 **WC 112,00** 137,76

MODEL  
**1145**



Nikiel Satyna - S05  
15-016



**BDR 219,00** 269,37



15-164 **WK 59,00** 72,57



15-165 **WB 59,00** 72,57



15-026 **WC 102,00** 125,46



Czarny Matowy - S19  
25-190



**BDR 219,00** 269,37



15-162 **WK 59,00** 72,57



15-163 **WB 59,00** 72,57



15-038 **WC 102,00** 125,46

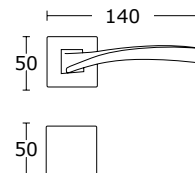

Tytan - S75  
15-017



**BDR 241,00** 296,43



15-187 **WK 64,90** 79,83



15-189 **WB 64,90** 79,83



15-035 **WC 112,00** 137,76



Chrom Satyna - S24  
15-015



**BDR 219,00** 269,37



15-160 **WK 59,00** 72,57



15-161 **WB 59,00** 72,57



15-029 **WC 102,00** 125,46



Mosiądz Antyczny - S73  
15-150



**BDR 241,00** 296,43



15-183 **WK 64,90** 79,83



15-185 **WB 64,90** 79,83



15-041 **WC 112,00** 137,76

MODEL  
**1125**



Chrom - S04  
15-067



**BDR 310,00** 381,30



15-180 **WK 64,90** 79,83



15-182 **WB 64,90** 79,83



15-032 **WC 112,00** 137,76

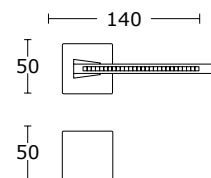

MODEL  
**1115**



Tytan - S75  
15-004



**BDR 269,00** 330,87



15-187 **WK 64,90** 79,83



15-189 **WB 64,90** 79,83



15-035 **WC 112,00** 137,76

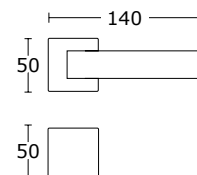

Mosiądz Antyczny - S73  
15-203



**BDR 269,00** 330,87



15-183 **WK 64,90** 79,83



15-185 **WB 64,90** 79,83



15-041 **WC 112,00** 137,76

MODEL  
**1085**



Mosiądz Antyczny - S73  
15-011



**BDR 264,00** 324,72



15-183 **WK 64,90** 79,83



15-185 **WB 64,90** 79,83



15-041 **WC 112,00** 137,76



Czarny Matowy - S19  
25-489



**BDR 239,00** 293,97



15-162 **WK 59,00** 72,57



15-163 **WB 59,00** 72,57



15-038 **WC 102,00** 125,46

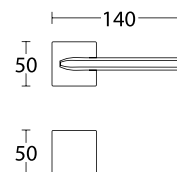

Nikiel Satyna - S05  
15-010



**BDR 239,00** 293,97



15-164 **WK 59,00** 72,57



15-165 **WB 59,00** 72,57



15-026 **WC 102,00** 125,46



Chrom Satyna - S24  
15-009



**BDR 239,00** 293,97



15-160 **WK 59,00** 72,57



15-161 **WB 59,00** 72,57



15-029 **WC 102,00** 125,46

MODEL  
**865**



Mosiądz Matowy - S26  
25-511



Czarny Matowy - S19  
15-008



**BDR 213,00** 261,99



15-412 **WK 64,90** 79,83



15-413 **WB 64,90** 79,83



15-414 **WC 112,00** 137,76



**BDR 195,00** 239,85



15-162 **WK 59,00** 72,57



15-163 **WB 59,00** 72,57



15-038 **WC 102,00** 125,46

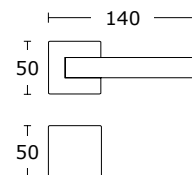

MADE  
IN  
GREECE



Chrom Satyna - S24  
15-006



Biały Matowy - S06  
25-468



Nikiel Satyna - S05  
15-007



**BDR 195,00** 239,85



15-160 **WK 59,00** 72,57



15-161 **WB 59,00** 72,57



15-029 **WC 102,00** 125,46



**BDR 213,00** 261,99



25-517 **WK 64,90** 79,83



25-518 **WB 64,90** 79,83



25-519 **WC 112,00** 137,76



**BDR 195,00** 239,85



15-164 **WK 59,00** 72,57



15-165 **WB 59,00** 72,57



15-026 **WC 102,00** 125,46



MODEL  
**925**



Nikiel Satyna - S05  
15-003



**BDR 194,00** 238,62



15-164 **WK 59,00** 72,57



15-165 **WB 59,00** 72,57



15-026 **WC 102,00** 125,46

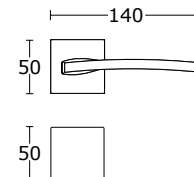

Chrom Satyna - S24  
15-002



**BDR 194,00** 238,62



15-160 **WK 59,00** 72,57



15-161 **WB 59,00** 72,57



15-029 **WC 102,00** 125,46



Mosiądz Matowy - S26  
15-395



**BDR 215,00** 264,45



15-412 **WK 64,90** 79,83



15-413 **WB 64,90** 79,83



15-414 **WC 112,00** 137,76



Mosiądz Antyczny - S73  
15-077



**BDR 215,00** 264,45



15-183 **WK 64,90** 79,83



15-185 **WB 64,90** 79,83



15-041 **WC 112,00** 137,76

MODEL  
**785**



Czarny Matowy - S19



szt. **126,50** 155,59



kpl. **253,00** 311,19

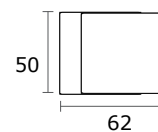

←50→



Gałki występują jako ruchome i stałe, pasują do klamek Convex na rozecie kwadratowej.  
Zapytaj również o cenę gałko - klamki.

MODEL  
**697**



Czarny Matowy - S19



szt. **104,50** 128,53



kpl. **209,00** 257,07

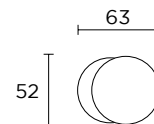

←50→



Gałki występują jako ruchome i stałe, pasują do klamek Convex na rozecie okrągłej.  
Zapytaj również o cenę gałko - klamki.



KLAMKI NA ROZETACH OKRĄGLYCH

[www.zamontujto.pl](http://www.zamontujto.pl)

MODEL  
**2095**

*Nowości*



Biały - S96  
25-539



**BDR 153,00** 188,19



25-540 **WK 64,90** 79,83



25-542 **WB 64,90** 79,83



25-541 **WC 112,00** 137,76

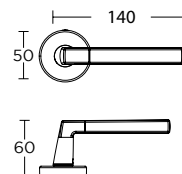

MADE  
IN  
GREECE



Czarny Matowy - S19  
25-543



**BDR 141,00** 173,43



15-572 **WK 59,00** 72,57



15-574 **WB 59,00** 72,57



15-573 **WC 102,00** 125,46



Bordowy - S23  
25-547



**BDR 153,00** 188,19



25-544 **WK 64,90** 79,83



25-546 **WB 64,90** 79,83







25-545 **WC 112,00** 137,76

MODEL  
**1755**



Czarny Matowy - S19  
25-445



	<b>BDR</b> <b>162,00</b>	199,26
	15-572 <b>WK</b> <b>59,00</b>	72,57
	15-574 <b>WB</b> <b>59,00</b>	72,57
	15-573 <b>WC</b> <b>102,00</b>	125,46

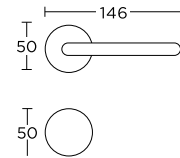





MODEL  
**425**



Mosiądz Antyczny - S73  
15-091



	<b>BDR</b> <b>209,00</b>	257,07
	15-190 <b>WK</b> <b>64,90</b>	79,83
	15-192 <b>WB</b> <b>64,90</b>	79,83
	15-095 <b>WC</b> <b>112,00</b>	137,76

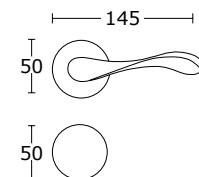

MODEL  
**1515**

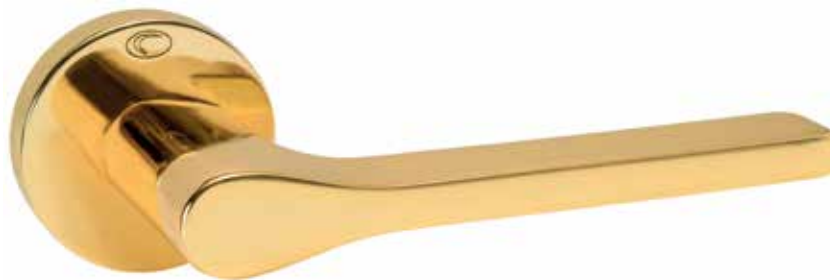

Złoty - S20  
15-515



**BDR 195,00** 239,85



15-569 **WK 64,90** 79,83



15-571 **WB 64,90** 79,83



15-570 **WC 112,00** 137,76

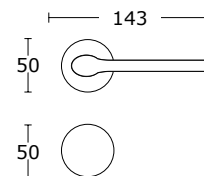

Czarny Matowy - S19  
25-187



**BDR 178,00** 218,94



15-572 **WK 59,00** 72,57



15-574 **WB 59,00** 72,57



15-573 **WC 102,00** 125,46



Chrom Satyna - S24  
15-335



**BDR 178,00** 218,94



15-166 **WK 59,00** 72,57



15-167 **WB 59,00** 72,57



15-055 **WC 102,00** 125,46

MODEL  
**1515**



Nikiel Satyna - S05  
15-333



	<b>BDR</b> <b>178,00</b>	218,94
	15-168 <b>WK</b> <b>59,00</b>	72,57
	15-169 <b>WB</b> <b>59,00</b>	72,57
	15-052 <b>WC</b> <b>102,00</b>	125,46

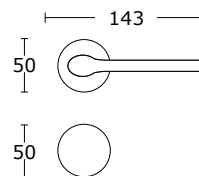

MADE  
IN  
GREECE



Chrom - S04  
15-334



	<b>BDR</b> <b>195,00</b>	239,85
	15-196 <b>WK</b> <b>64,90</b>	79,83
	15-198 <b>WB</b> <b>64,90</b>	79,83
	15-058 <b>WC</b> <b>112,00</b>	137,76



Biały Matowy - S06  
25-504



	<b>BDR</b> <b>195,00</b>	239,85
	25-514 <b>WK</b> <b>64,90</b>	79,83
	25-515 <b>WB</b> <b>64,90</b>	79,83
	25-516 <b>WC</b> <b>112,00</b>	137,76



Mosiądz Satyna - S02  
15-514



	<b>BDR</b> <b>195,00</b>	239,85
	15-415 <b>WK</b> <b>64,90</b>	79,83
	15-406 <b>WB</b> <b>64,90</b>	79,83
	15-416 <b>WC</b> <b>112,00</b>	137,76

MODEL  
**1505**



Nikiel Satyna - S05  
15-336



**BDR 171,00** 210,33



15-168 **WK 59,00** 72,57



15-169 **WB 59,00** 72,57



15-052 **WC 102,00** 125,46

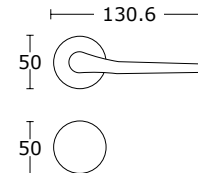

MADE  
IN  
GREECE



Chrom Satyna - S24  
15-338



**BDR 171,00** 210,33



15-166 **WK 59,00** 72,57



15-167 **WB 59,00** 72,57



15-055 **WC 102,00** 125,46



Chrom - S04  
15-337



**BDR 187,00** 230,01



15-196 **WK 64,90** 79,83



15-198 **WB 64,90** 79,83



15-058 **WC 112,00** 137,76



MODEL  
**1505**



Złoty - S20  
15-512



**BDR 187,00** 230,01



15-569 **WK 64,90** 79,83



15-571 **WB 64,90** 79,83



15-570 **WC 112,00** 137,76

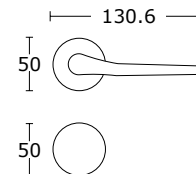

Czarny Matowy - S19  
25-188



**BDR 171,00** 210,33



15-572 **WK 59,00** 72,57



15-574 **WB 59,00** 72,57



15-573 **WC 102,00** 125,46



Mosiądz Satyna - S02  
15-418



**BDR 187,00** 230,01



15-415 **WK 64,90** 79,83



15-406 **WB 64,90** 79,83



15-416 **WC 112,00** 137,76

MODEL  
**1485**



Mosiądz Satyna - S02  
15-417



**BDR 195,00** 239,85



15-415 **WK 64,90** 79,83



15-406 **WB 64,90** 79,83



15-416 **WC 112,00** 137,76

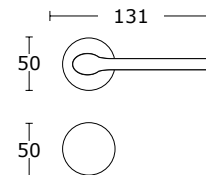

MADE  
IN  
GREECE



Chrom - S04  
15-344



**BDR 195,00** 239,85



15-196 **WK 64,90** 79,83



15-198 **WB 64,90** 79,83



15-058 **WC 112,00** 137,76



Chrom Satyna - S24  
15-346



**BDR 178,00** 218,94



15-166 **WK 59,00** 72,57



15-167 **WB 59,00** 72,57



15-055 **WC 102,00** 125,46



Nikiel Satyna - S05  
15-343



**BDR 178,00** 218,94



15-168 **WK 59,00** 72,57



15-169 **WB 59,00** 72,57



15-052 **WC 102,00** 125,46

MODEL  
**1485**



Czarny Matowy - S19  
25-483



**BDR 178,00** 218,94



15-572 **WK 59,00** 72,57



15-574 **WB 59,00** 72,57



15-573 **WC 102,00** 125,46

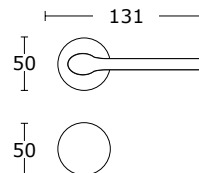

MADE  
IN  
GREECE



Biały Matowy - S06  
25-507



**BDR 195,00** 239,85



25-514 **WK 64,90** 79,83



25-515 **WB 64,90** 79,83



25-516 **WC 112,00** 137,76



Mosiądz Matowy - S26  
25-508



**BDR 195,00** 239,85



25-143 **WK 64,90** 79,83



25-144 **WB 64,90** 79,83



25-145 **WC 112,00** 137,76



Złoty - S20  
15-511



**BDR 195,00** 239,85



15-569 **WK 64,90** 79,83



15-571 **WB 64,90** 79,83



15-570 **WC 112,00** 137,76

## PROJEKTANCI CONVEX

Filozofię Convex najlepiej można opisać jako model czterofilarowy. Kreatywność, Innowacja, Technologia i Pasja. Wszystkie produkty ucieleśniają te podstawowe wartości, dzięki czemu zapewniona jest ich jakość i trwałość. Convex to jednostka produkcyjna oparta na nowoczesnej dynamice technologicznej i artystycznej, która nieustannie stara się doskonalić i dalej ewoluować. Dzięki takiemu starannemu podejściu firma Convex wytwarza pionierskie produkty o wysokich walorach estetycznych, jest rozpoznawana na całym świecie i wyróżniana za swoją jakość. Co więcej, Convex zdobył nagrody za wzornictwo dzięki utalentowanemu zespołowi projektantów firmy.

Yianis Georgaras



**Yannis Georgaras** urodził się w Atenach w 1973 roku, studiował wzornictwo przemysłowe w AKTO School of Applied Arts, i kontynuował na Middlesex University w Londynie. Projektuje oryginalne obiekty dla Greckich firm i organizacji. Od 2003 do 2009 roku brał udział w międzynarodowych wystawach IMM Cologne oraz DESTE Foundation w 2005 roku. W 2008 roku jego krzesło „TETRA”, wyprodukowane przez Grecką firmę VARANGIS, otrzymało nagrodę „The Red Dot Design Award”. Kolejny raz nagrodę „The Red Dot Design Award” otrzymał w 2013 roku za projekt klamki model 2055 wyprodukowanej przez firmę CONVEX S.A.

Christina Perdikaki



**Christina Perdikaki** urodziła się w 1980 roku, studiowała architekturę na Universitatea de Arhitectura si Urbanism „Ion Mincu” w Bukareszcie, a także wzornictwo przemysłowe na Scuola Politecnica di design SPD w Mediolanie. Łączenie przez nią jej twórczej umiejętności z nowoczesną technologią, pozwala stworzyć dowolną formę innowacyjnego projektowania koncentrującą się na meblach i sprzętach gospodarstwa domowego. Na wystawie LED (Lighting Exhibition Design), która odbyła się w Mediolanie w 2009 roku, w kategorii projekt, zdobyła nagrodę „The Ride it to Light”.

Teseo Berghella



**Teseo Berghella** jest kreatywnym dyrektorem artystycznym, który ma doświadczenie w pracy z najbardziej znanymi międzynarodowymi agencjami reklamowymi, takimi jak: J.W.Thompson, MacCann (Mediolan i Paryż), Ogilvy, Lintas, Ted Bates, Leo Burnett. Współpracował także z Esquire i Mac Cann w Brazylii. Teseo jest także wykładowcą na kursach mistrzowskich w zakresie sztuki i wzornictwa mebli w Mediolanie, a także wykładał w NABA i Istituto Marangoni w Mediolanie. Obecnie pracuje jako projektant i dyrektor artystyczny w różnych dziedzinach, takich jak projektowanie wnętrz, kuchnia i wyposażenie domu oraz projektowanie łazienek.

## PROJEKTANCI CONVEX

Valentino Marengo



### Valentino Marengo

Urodził się w 1968 roku w Turynie. Studiował na Akademii Sztuk Pięknych w Turynie a następnie kontynuował studia w Mediolanie, które ukończył tytułem magistra projektowania produktów w tamtejszej Domus Academy.

Dziś mieszka w Atenach, gdzie pracuje jako projektant przemysłowy dla firm greckich i włoskich oraz scenograf.

W 2004 roku współpracował z zespołem projektowym Pininfarina Extra, m.in. przy koncepcji znicza olimpijskiego na Zimowe Igrzyska Olimpijskie Turyn 2006.

Jako scenograf pracował dla teatrów państwowych i innych scen w Grecji. Współpracuje z Muzeum Benaki i Muzeum Sztuki Cykladzkiej.

Niedawno zaprojektował logo Opery Ateńskiej. Jako artysta wizualny pokazywał swoje prace na wielu wystawach w Europie.

Yianis Gikas



**Yianis Gikas** urodził się w Atenach w Grecji. Jego wykształcenie łączy informatykę i wzornictwo.

Yianis wykorzystuje funkcjonalność, jako ostateczny cel jego projektów, badając potencjalne reakcje emocjonalne jakie mogą generować.

Widzi projekt jako proces zaspokojenia zarówno materialnych jak i niematerialnych potrzeb.

W 2009 roku, jego krzesło w stylu monarchistycznym, wyprodukowane przez belgijską firmę FELD, otrzymało nagrodę „The Red Dot Design Award”.

Oleg Suzdalev



**Oleg Suzdalev** to projektant przemysłowy, który koncentruje się na akcesoriach meblowych.

Jego projekty obejmują również oprawy, baterie zlewozmywakowe, wanny i oczywiście klamki.

W 2007 r. ukończył studia w zakresie sztuki użytkowej w Kijowie na Ukrainie.

Sotiris Lazou



**Sotiris Lazou** urodził się w Atenach w 1965 roku.

Studiował projektowanie wnętrz w Technological Educational Institution w Atenach i wzornictwo przemysłowe w Mediolanie na słynnej Akademii DOMUS pod nadzorem profesorów Andrea Branzi, Isao Hosoe i Ezio Manzini.

Projekty Sotirisa otrzymały międzynarodowe uznanie. Jego stół „Cosmos” zdobył w 2008 roku nagrodę „Good Design Award”. Był on również nominowany w 2010 roku do „Designpreis Deutschland” (Nagrody Wzornictwa) w Niemczech.

## AWARDED DESIGNERS & PREMIUM

[www.zamontujto.pl](http://www.zamontujto.pl)

MODEL  
**2405**



design by **Christina Perdikaki**



Czarny Matowy - S19  
25-185



**BDR 310,00** 381,30



15-572 **WK 59,00** 72,57



15-574 **WB 59,00** 72,57



15-573 **WC 102,00** 125,46

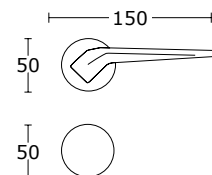

MADE  
IN  
GREECE



Mosiądz Satyna - S02  
15-382



**BDR 340,00** 418,20



15-415 **WK 64,90** 79,83



15-406 **WB 64,90** 79,83



15-416 **WC 112,00** 137,76



MODEL  
**2415**



design by **Yiannis Ghikas**

Brąz Matowy - S77  
25-496



	<b>BDR</b> <b>216,00</b>	265,68
	25-146 <b>WK</b> <b>64,90</b>	79,83
	15-148 <b>WB</b> <b>64,90</b>	79,83
	25-147 <b>WC</b> <b>112,00</b>	137,76

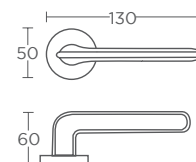

MODEL  
**2195**



design by **Yiannis Ghikas**

Chrom / Biały - S04 / S06  
15-347



	<b>BDR</b> <b>421,00</b>	517,83
	15-196 <b>WK</b> <b>64,90</b>	79,83
	15-198 <b>WB</b> <b>64,90</b>	79,83
	15-058 <b>WC</b> <b>112,00</b>	137,76

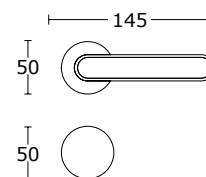

MODEL  
**2165**







design by **Yiannis Ghikas**



MADE  
IN  
GREECE

Czarny Matowy - S19  
15-023



	<b>BDR</b> <b>399,00</b> 490,77
	15-162 <b>WK</b> <b>59,00</b> 72,57
	15-163 <b>WB</b> <b>59,00</b> 72,57
	15-038 <b>WC</b> <b>102,00</b> 125,46

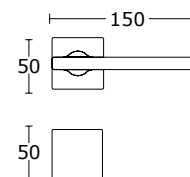



MODEL  
**1935**

*Nowości*



Mosiądz Matowy / Mosiądz Błyszczący - S26 S16  
25-553



**BDR 464,00** 570,72



25-143 **WK 64,90** 79,83



25-144 **WB 64,90** 79,83



25-145 **WC 112,00** 137,76



Mosiądz Antyczny / Złoty - S73 S20  
25-552



**BDR 512,00** 629,76



15-190 **WK 64,90** 79,83



15-192 **WB 64,90** 79,83



15-095 **WC 112,00** 137,76

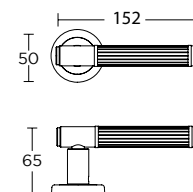

MODEL  
**1925**

*Mosiąże*



Mosiądz Antyczny / Złoty - S73 S20  
25-554



**BDR 376,00** 462,46

① ① 15-190 **WK 64,90** 79,83

② ② 15-192 **WB 64,90** 79,83

③ ③ 15-095 **WC 112,00** 137,76

MADE  
IN  
GREECE



Mosiądz Matowy / Mosiądz Błyszczący - S26 S16  
25-555



**BDR 376,00** 462,46

① ① 25-143 **WK 64,90** 79,83

② ② 25-144 **WB 64,90** 79,83

③ ③ 25-145 **WC 112,00** 137,76

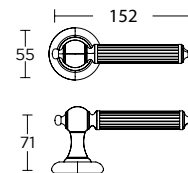

MODEL  
**1775**





design by **Teseo Berghella**



Mosiądz Antyczny - S73  
25-193



	<b>BDR</b> <b>269,00</b> 330,87
 15-190	<b>WK</b> <b>64,90</b> 79,83
 15-192	<b>WB</b> <b>64,90</b> 79,83
 15-095	<b>WC</b> <b>112,00</b> 137,76

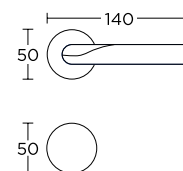

MODEL  
**1745**



Nikiel Satyna - S05  
25-140



**BDR 414,00** 509,22



15-168 **WK 59,00** 72,57



15-169 **WB 59,00** 72,57



15-052 **WC 102,00** 125,46

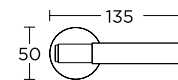

Mosiądz Matowy - S26  
25-141



**BDR 456,00** 560,88



25-143 **WK 64,90** 79,83



25-144 **WB 64,90** 79,83



25-145 **WC 112,00** 137,76



Brąz Matowy - S77  
25-142



**BDR 456,00** 560,88



25-146 **WK 64,90** 79,83



25-148 **WB 64,90** 79,83



25-147 **WC 112,00** 137,76



Czarny Matowy - S19  
25-352



**BDR 414,00** 509,22



15-572 **WK 59,00** 72,57



15-574 **WB 59,00** 72,57



15-573 **WC 102,00** 125,46

MODEL  
**1625**



design by **Oleg Suzdalev**



Mosiądz Antyczny - S73  
15-854



**BDR 229,00** 281,67



15-190 **WK 64,90** 79,83



15-192 **WB 64,90** 79,83



15-095 **WC 112,00** 137,76

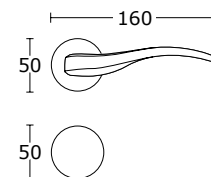

 **MADE  
IN  
GREECE**



Czarny Matowy - S19  
15-853



**BDR 209,00** 257,07



15-572 **WK 59,00** 72,57



15-574 **WB 59,00** 72,57



15-573 **WC 102,00** 125,46

## ROZETA QR5WK



Chrom - S04

Nikiel Satyna S05 15-164	<b>59,00</b>	72,57
Czarny Matowy S19 15-162	<b>59,00</b>	72,57
Chrom Satyna S24 15-160	<b>59,00</b>	72,57
Mosiądz Satyna S02 25-370	<b>64,90</b>	79,83
Chrom S04 15-180	<b>64,90</b>	79,83
Biały Matowy S06 25-517	<b>64,90</b>	79,83
Mosiądz Matowy S26 15-412	<b>64,90</b>	79,83
Mosiądz Antyczny S73 15-183	<b>64,90</b>	79,83
Tytan S75 15-187	<b>64,90</b>	79,83

## ROZETA QR5WB



Nikiel Satyna - S02

Nikiel Satyna S05 15-165	<b>59,00</b>	72,57
Czarny Matowy S19 15-163	<b>59,00</b>	72,57
Chrom Satyna S24 15-161	<b>59,00</b>	72,57
Mosiądz Satyna S02 25-372	<b>64,90</b>	79,83
Chrom S04 15-182	<b>64,90</b>	79,83
Biały Matowy S06 25-518	<b>64,90</b>	79,83
Mosiądz Matowy S26 15-413	<b>64,90</b>	79,83
Mosiądz Antyczny S73 15-185	<b>64,90</b>	79,83
Tytan S75 15-189	<b>64,90</b>	79,83

## ROZETA QR5WC



Tytan - S75

Nikiel Satyna S05 15-026	<b>102,00</b>	125,46
Czarny Matowy S19 15-038	<b>102,00</b>	125,46
Chrom Satyna S24 15-029	<b>102,00</b>	125,46
Mosiądz Satyna S02 25-371	<b>112,00</b>	137,76
Chrom S04 15-032	<b>112,00</b>	137,76
Biały Matowy S06 25-519	<b>112,00</b>	137,76
Mosiądz Matowy S26 15-414	<b>112,00</b>	137,76
Mosiądz Antyczny S73 15-041	<b>112,00</b>	137,76
Tytan S75 15-035	<b>112,00</b>	137,76

## ROZETA R5WK



Mosiądz Satyna - S02

Nikiel Satyna S05 15-168	<b>59,00</b>	72,57
Czarny Matowy S19 15-572	<b>59,00</b>	72,57
Chrom Satyna S24 15-166	<b>59,00</b>	72,57
Mosiądz Satyna S02 15-415	<b>64,90</b>	79,83
Chrom S04 15-196	<b>64,90</b>	79,83
Biały Matowy S06 25-514	<b>64,90</b>	79,83
Złoty S20 15-569	<b>64,90</b>	79,83
Bordowy S23 25-544	<b>64,90</b>	79,83
Mosiądz Matowy S26 25-143	<b>64,90</b>	79,83
Mosiądz Antyczny S73 15-190	<b>64,90</b>	79,83
Brąz Matowy S77 25-146	<b>64,90</b>	79,83
Biały S96 25-540	<b>64,90</b>	79,83

## ROZETA R5WB



Mosiądz Antyczny - S73

Nikiel Satyna S05 15-169	<b>59,00</b>	72,57
Czarny Matowy S19 15-574	<b>59,00</b>	72,57
Chrom Satyna S24 15-167	<b>59,00</b>	72,57
Mosiądz Satyna S02 15-406	<b>64,90</b>	79,83
Chrom S04 15-198	<b>64,90</b>	79,83
Biały Matowy S06 25-515	<b>64,90</b>	79,83
Złoty S20 15-571	<b>64,90</b>	79,83
Bordowy S23 25-546	<b>64,90</b>	79,83
Mosiądz Matowy S26 25-144	<b>64,90</b>	79,83
Mosiądz Antyczny S73 15-192	<b>64,90</b>	79,83
Brąz Matowy S77 25-148	<b>64,90</b>	79,83
Biały S96 25-542	<b>64,90</b>	79,83

## ROZETA R5WC



Brąz Matowy - S77

Nikiel Satyna S05 15-052	<b>102,00</b>	125,46
Czarny Matowy S19 15-573	<b>102,00</b>	125,46
Chrom Satyna S24 15-055	<b>102,00</b>	125,46
Mosiądz Satyna S02 15-416	<b>112,00</b>	137,76
Chrom S04 15-058	<b>112,00</b>	137,76
Biały Matowy S06 25-516	<b>112,00</b>	137,76
Złoty S20 15-570	<b>112,00</b>	137,76
Bordowy S23 25-545	<b>112,00</b>	137,76
Mosiądz Matowy S26 25-145	<b>112,00</b>	137,76
Mosiądz Antyczny S73 15-095	<b>112,00</b>	137,76
Brąz Matowy S77 25-147	<b>112,00</b>	137,76
Biały S96 25-541	<b>112,00</b>	137,76

## ROZETA QRS5WK



THIN

Czarny Matowy - S19

Nikiel Satyna S05 25-439	<b>68,00</b>	83,64
Czarny Matowy S19 25-436	<b>68,00</b>	83,64
Chrom Satyna S24 25-438	<b>68,00</b>	83,64
Mosiądz Satyna S02 25-437	<b>74,00</b>	91,02
Chrom S04 25-435	<b>74,00</b>	91,02
Złoty S20 25-440	<b>74,00</b>	91,02

## ROZETA QRS5WB



THIN

Złoty - S20

Nikiel Satyna S05 25-433	<b>68,00</b>	83,64
Czarny Matowy S19 25-430	<b>68,00</b>	83,64
Chrom Satyna S24 25-432	<b>68,00</b>	83,64
Mosiądz Satyna S02 25-431	<b>74,00</b>	91,02
Chrom S04 25-429	<b>74,00</b>	91,02
Złoty S20 25-434	<b>74,00</b>	91,02

## ROZETA QRS5WC



THIN

Chrom Satyna - S24

Nikiel Satyna S05 25-427	<b>109,00</b>	134,07
Czarny Matowy S19 25-424	<b>109,00</b>	134,07
Chrom Satyna S24 25-426	<b>109,00</b>	134,07
Mosiądz Satyna S02 25-425	<b>119,00</b>	146,37
Chrom S04 25-383	<b>119,00</b>	146,37
Złoty S20 25-428	<b>119,00</b>	146,37

# ASSEMBLY / MONTAŻ

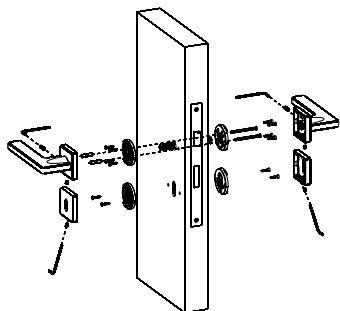

MONTAŻ KLAMKI  
NA ROZECIE KWADRATOWEJ

DOOR HANDLE  
WITH 2145 ROSETTE ASSEMBLY

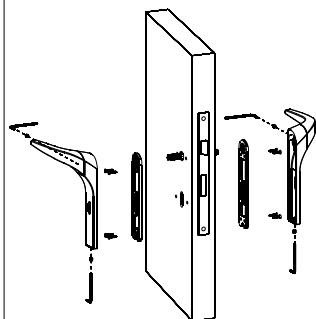

MONTAŻ KLAMKI  
MODEL 2055

DOOR HANDLE  
WITH 2055 ASSEMBLY PLATE

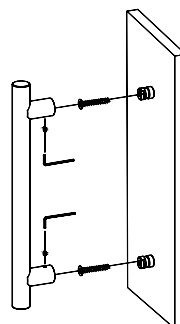

MONTAŻ POCHWYTU  
JEDNOSTRONNEGO  
NA DREWNOWKRĘT

SINGLE PULL HANDLE ASSEMBLY  
WITHOUT HOLES

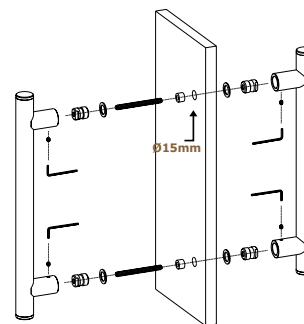

MONTAŻ POCHWYTU  
DWUSTRONNEGO  
DO DRZWI SZKLANYCH

PAIR PULL HANDLES ASSEMBLY  
IN GLASS

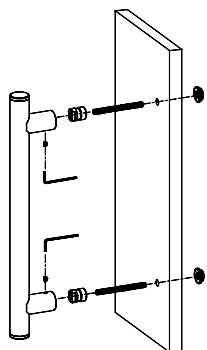

MONTAŻ POCHWYTU  
JEDNOSTRONNEGO  
NA PRZESTRZAŁ

PULL HANDLES ASSEMBLY  
THROUGH HOLES

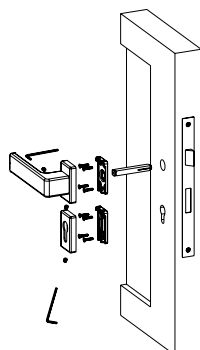

MONTAŻ KLAMKI  
NA ROZECIE Q11

DOOR HANDLES  
WITH NARROW ROSETTE  
ASSEMBLY

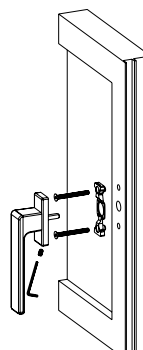

MONTAŻ KLAMKI OKIENNEJ  
I BALKONOWEJ

WINDOW HANDLE ASSEMBLY

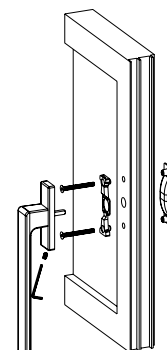

MONTAŻ KLAMKI OKIENNEJ  
I BALKONOWEJ

WINDOW HANDLE ASSEMBLY



**Roothkin sp. z o.o.**

ul. Wieniawskiego 18, 41-506 Chorzów

zamowienia@roothkin.pl  
biuro@roothkin.pl

kom. + 48 798 478 698

kom. + 48 532 726 624

tel. + 48 32 248 70 08

fax + 48 32 248 70 08

Firma Roothkin jest wyłącznym dystrybutorem marki Convex

Telefon do przedstawiciela marki Convex: + 48 532 726 622

Twoja platforma do zamawiania:

**[www.b2b.roothkin.pl](http://www.b2b.roothkin.pl)**

[www.roothkin.pl](http://www.roothkin.pl)

Obserwuj nas na 



**[www.zamontujto.pl](http://www.zamontujto.pl)**